

# 100% WANDERLUST

**PÖSSL**  
*The Original*



en

2024

HANDMADE  
IN GERMANY  
SINCE 1989

**D**Line

TRENTA

summit summit summit  
prime Shine

**H**Line





## Welcome to the original.

### Welcome to Pössl.

The world is in flux - and that's true for the world of travel, too. Continuity and stability are the new benchmarks of mobile travel. As a pioneer in this field, that is exactly what PÖSSL offers fans of van-based motorhomes: quality, comfort and innovation - values on which you can build and happily take on the road.

These values are also reflected in our production processes and product development. Cutting-edge technologies such as laser robots and continuous development are just two of the significant factors in this.

**Jump in and take a trip with PÖSSL - the original.**



PAGES  
6-15

**D** Line



## D FOR DELIGHT ... UNENDING DELIGHT

The Pössl D-Line offers the widest choice - from compact and agile to spacious with lots of room, with numerous different models. The D-Line is where you'll find the very PÖSSL for you.

# STEP INTO THE WORLD OF PÖSSL!

TRENTA

PAGES  
16-23



## LA DOLCE VITA

The Trenta not only exudes the sense of Bella Italia; it is also the expression of 30 years of PÖSSL know-how and experience.



summit

summit  
prime

summit  
Shine

PAGES  
24-47

## THE SUMMIT OF MOBILE FREEDOM

Whether it's the Summit, Summit Prime or Summit Shine - the unparalleled sense of space in the Summit models will make every camping fan's heart beat a little faster.



PAGES  
48-53

H line

## AT HOME THE WORLD OVER

The H-Line is a special home-from-home for those who love travelling out into the world. There are three models to satisfy every desire.



# D FOR DELIGHT ... UNENDING DELIGHT



**D** line

If you choose the PÖSSL D-Line, you will also benefit from a wide selection. Here you will find the right vehicle to suit your taste and needs. From compact and agile to spacious with lots of room. The D-Line has exactly the right PÖSSL for you.

# D Line Highlights



## POP-TOP ROOF

Optional for many models: a pop-top roof for two extra sleeping berths. Bed space: 200 x 130 cm.

## XXL STORAGE SPACE

Our rear beds can be dismantled, folded and stacked away. It's so easy to always have the optimum and maximum storage space



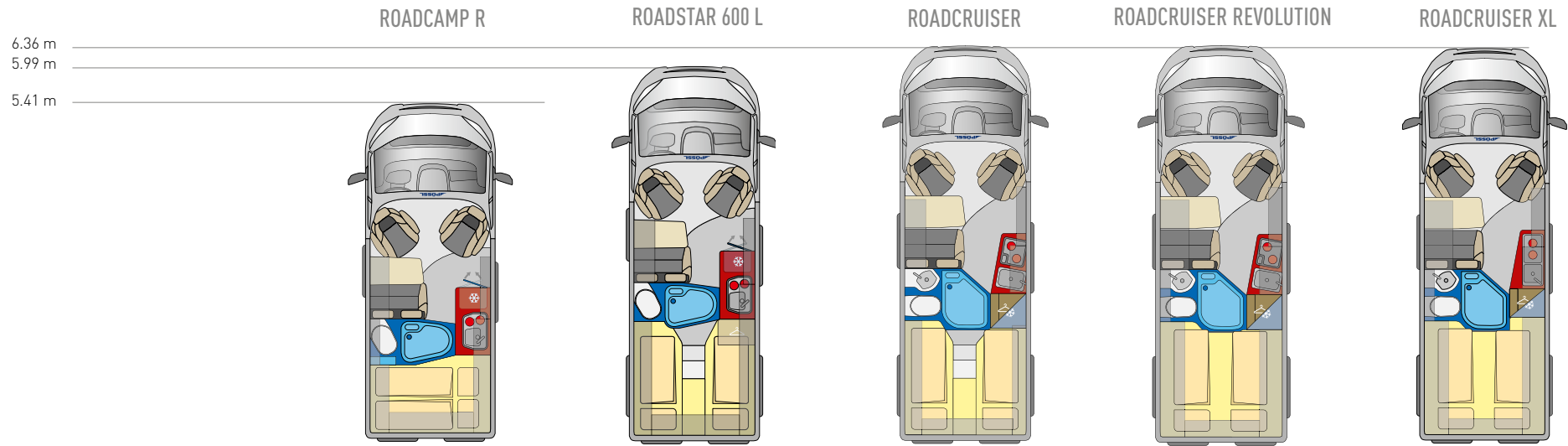

PAGE	9	10	11	12	12
<b>DIMENSIONS in mm</b>					
Length (approx.)	5,413	5,998	6,358	6,358	6,358
Width (approx.)	2,050	2,050	2,050	2,050	2,050
Height (approx.)	2,580	2,580	2,580	2,830	2,830
Wheelbase (approx.)	3,450	4,035	4,035	4,035	4,035
Interior height (approx.)	1,905	1,905	1,905	2,130	2,130
<b>WEIGHT AND MAXIMUM RECOMMENDED LOAD in kg</b>					
Gross vehicle weight (standard)	3,500	3,300	3,500	3,500	3,500
Mass in running order (approx.)*	2,720	2,820	2,970	3,060	3,060
Maximum recommended load with 20 l water (approx.)	780	480	530	440	440
Towing capacity, unbraked/braked**	750 / 2,500**	750 / 2,500**	750 / 2,500**	750 / 3,000	750 / 3,000

\* Weight specifications with standard built-in equipment. 165/180 HP and higher, +40 kg. The maximum recommended load will change with instalment of optional extras. \*\*Heavy/Maxi 750/3,000 kg

<b>ON-BOARD TECHNICAL EQUIPMENT</b>					
Heater	Truma Combi 4	Truma Combi 4	Truma Combi 4	Truma Combi 4	Truma Combi 4
Boiler volume, l (approx.)	10	10	10	10	10
Fresh water tank, l (approx.)	100	100	100	100	100
Wastewater tank, l (approx.)	92	92	92	92	92
Gas cylinder box for (kg)	2 x 11	2 x 11	2 x 11	2 x 11	2 x 11
Battery charger, A	18	18	18	18	18
Battery	12V / 95 Ah	12V / 95 Ah	12V / 95 Ah	12V / 95 Ah	12V / 95 Ah
230V power sockets	2	2	2	2	2
Refrigerator, l (capacity/for freezer)	approx. 100 / 8	approx. 100 / 8	approx. 84 / 6	approx. 84 / 6	approx. 84 / 6
Absorber/compressor	Compressor	Compressor	Compressor	Compressor	Compressor

<b>LIVING AREA FITTINGS AND FEATURES</b>					
Plastic insulating windows (blinds)	4	6	6	6	6
Operable skylight with blackout and flyscreen blinds	1	1	1	1	1
Compact operable skylight with blackout and flyscreen blinds	-	1	1	1	1
Seats/three-point safety belts	4 / 4	4 / 4	4 / 4	4 / 4	4 / 4
Berths	2 (+1 optional)	2 (+1 optional)	2 (+1 optional)	2 (+1+2 optional)	2 (+1 optional)
Rear bed/single bed, mm (approx.)	1,960 x 1,320/1,170	1,930/1,800 x 829	1,980/1,930 x 1,900	1,980/1,930 x 1,900	1,980/2,080 x 1,900
Bed lateral to sliding door, mm (approx., as standard)	1,800 x 700	1,800 x 700	1,800 x 700	1,800 x 700	1,800 x 700
Extra bed in the rear (approx., as standard)	-	-	-	1,800 x 1,600	-
Possible Isofix fittings	-	-	2	2	2





# ROADCAMP R



**Extra bedroom**

Additional storage compartments at the top-end of the bed

**Practical central bathroom**

Extra bathroom space and it doubles as a room divider

**Elegance version (optional)**

Marais interior, alternative tabletop (optional)

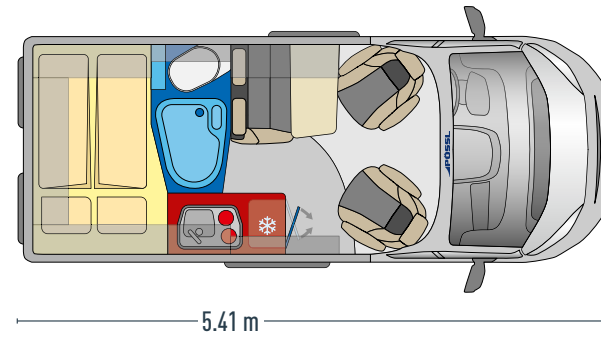

**Extra short vehicle – just the right everyday companion**

**With practical folding wash-hand basin in the bathroom for greater space**

**The double-hinged refrigerator door provides you with access from the outside and inside**





# ROADSTAR 600 L



LOOK INSIDE

360°

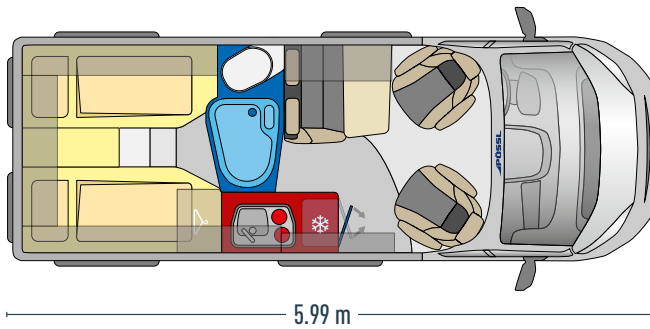

- ✓ Spacious single beds for sleeping comfort like at home
- ✓ Large separate wall locker under the single bed
- ✓ Practical folding wash-hand basin in the bathroom for greater space
- ✓ The double-hinged refrigerator doors provides you with access from the outside and inside

### Elegance version (optional)

Lime interior, alternative tabletop (optional)

### Cooking just like at home

Functional with space-optimised cabinets and drawers



### Separable bedroom

Large, comfortable and ideal when someone wants to sleep longer



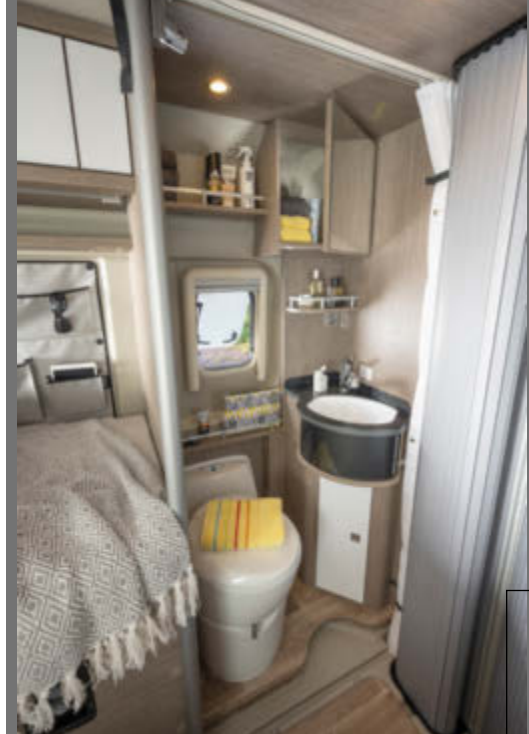

**D**LINE

# ROADCRUISER



**Extra-large kitchenette**  
With equally extra-large refrigerator

**Central bathroom**  
Bathroom and room divider in one

**Elegance version (optional)**  
Wohnwelt Marais, Tischplatte alternativ (optional)

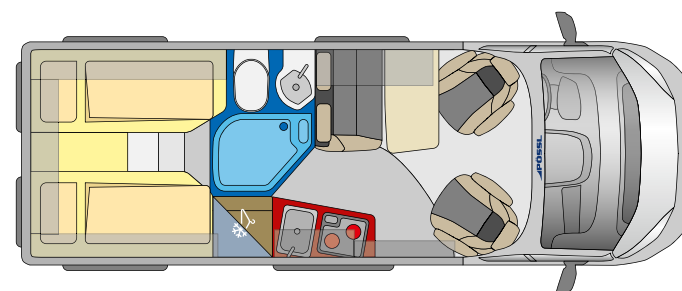

6.36 m

- ✓ **Elevated refrigerator – super easy to reach. Also optional with Slimtower**
- ✓ **For convivial gatherings of up to four people**
- ✓ **Flexible bathroom with top quality roller blinds – also ideal as a room divider**
- ✓ **Spacious single beds for sleeping comfort like at home**



LOOK INSIDE

360°

# ROADCRUISER REVOLUTION

### Elegance version (optional)

Silver interior (optional), alternative tabletop (optional)

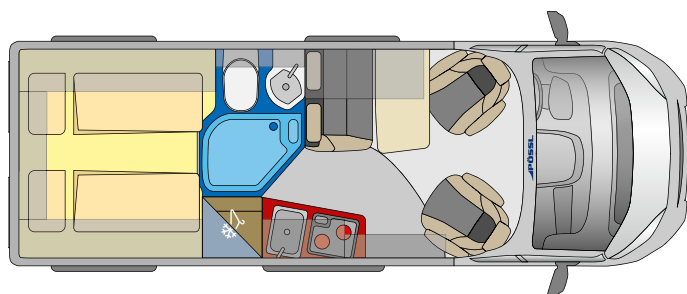

6.36 m

### Conveniently create storage space

Electrically height-adjustable bed, second control panel (optional)

### Convivial seating area

Plenty of room for four people on the road and at the destination



- ✓ Elevated refrigerator – super easy to reach. Optional Slimtower
- ✓ Electrically adjustable bed for extra flexibility
- ✓ Sophisticated light design with extra lighting
- ✓ With a particularly expansive sense of space thanks to the 213 cm interior headroom



**D**line

# ROADCRUISER XL



**Large shower**  
Home-like levels of comfort

**Kitchenette**  
With elevated refrigerator and spacious wardrobe

**Elegance version (optional)**  
Marais interior, alternative tabletop (optional)

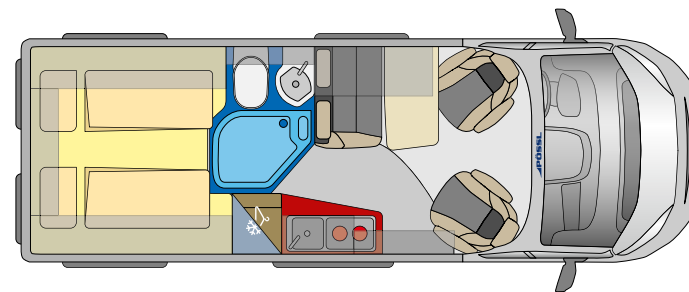

6.36 m

- Separate bathroom** ✓
- A real miracle of storage space with numerous compartments and cabinets** ✓
- Ideal for tall campers with 208 cm extra-long bed space** ✓
- With a particularly expansive sense of space thanks to the 213 cm of interior headroom** ✓



# D Line

## Interior

DECOR



### ELEGANCE VERSION

Dakota Oak wood decor with ambient overhead locker and Marais standard interior.

## INTERIORS

(standard or optional depending on version)



**TIMELESS INTERIOR**



**MARAIS INTERIOR**



**SILVER INTERIOR**



**LIMETTE INTERIOR**

# LA DOLCE VITA



## TRENTA

Pössl Trenta. Ready for the next 30 years. The Trenta not only exudes the sense of la dolce Vita and Bella Italia, it is also an expression of 30 years of experience in constructing smart compact motor homes. With its open-space interior, it offers the same head and legroom as liner motorhomes. The unique lighting concept and exclusive design make the Trenta a very special one of its kind. Just like its owners.



# TRENTA Highlights



## SLIM KITCHEN

in contemporary design and a work surface at ideal working height.



## UNIQUE LIGHTING CONCEPT

Ceiling cabinets with indirect lighting.



## TOP QUALITY WALL PANELLING

in the seating area and sleeping area (Trenta 640 only) for a unique interior ambience.



## CUSTOM-DESIGNED

Tiberino interior design with matching Pacco special cushions.



## GREATER SENSE OF SPACE

Open cab canopy and additional backlit storage compartments.



## TWO-TONE OVERHEAD LOCKERS

underscore the contemporary design.



## EXTERIOR DESIGN

Colour-coordinated lamination and portholes round off the elegant exterior design (optional; standard in Trenta 640).

TRENTA 540 R

TRENTA 600

TRENTA 600 R

TRENTA 640

6.36 m  
5.99 m  
5.41 m

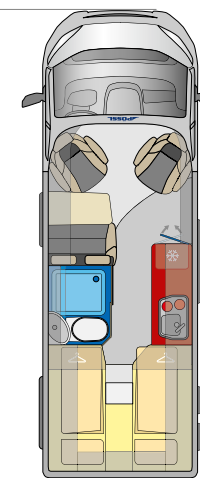
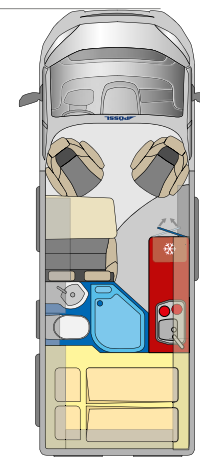
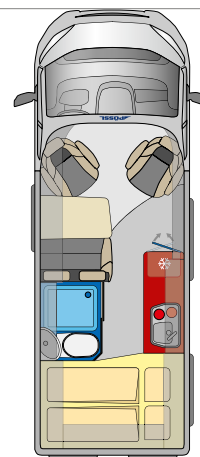
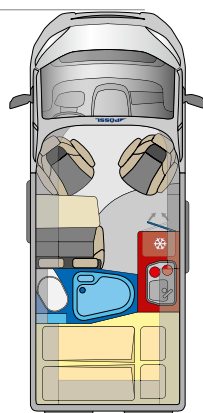

PAGE

17

18

19

20

DIMENSIONS in mm				
Length (approx.)	5,413	5,998	5,998	6,358
Width (approx.)	2,050	2,050	2,050	2,050
Height (approx.)	2,580	2,580	2,580	2,580
Wheelbase (approx.)	3,450	4,035	4,035	4,035
Interior height (approx.)	1,905	1,905	1,905	1,905

WEIGHT AND MAXIMUM RECOMMENDED LOAD in kg				
Gross vehicle weight (standard)	3,500	3,500	3,500	3,500
Mass in running order (approx.)*	2,720	2,820	2,820	2,970
Maximum recommended load with 20 l water (approx.)	780	680	680	530
Towing capacity, unbraked/braked**	750 / 2,500**	750 / 2,500**	750 / 2,500**	750 / 2,500**

\* Weight specifications with standard built-in equipment. 165/180 HP and higher, +40 kg. The maximum recommended load will change with instalment of optional extras. \*\* Heavy/Maxi 750/3,000 kg

ON-BOARD TECHNICAL EQUIPMENT				
Heater	Truma Combi 4	Truma Combi 4	Truma Combi 4	Truma Combi 4
Boiler volume, l (approx.)	10	10	10	10
Fresh water tank, l (approx.)	100	100	100	100
Wastewater tank, l (approx.)	92	92	92	92
Gas cylinder box for (kg)	2 x 11	2 x 11	2 x 11	2 x 11
Battery charger, A	18	18	18	18
Battery	12V / 95 Ah	12V / 95 Ah	12V / 95 Ah	12V / 95 Ah
230V power sockets	2	2	2	2
Refrigerator, l (capacity/for freezer)	approx. 100 / 8	approx. 100 / 8	approx. 100 / 8	approx. 100 / 8
Absorber/compressor	Compressor	Compressor	Compressor	Compressor

LIVING AREA FITTINGS AND FEATURES				
Plastic insulating windows (blinds)	4	5	5	3 + 2 Bullaugen
Operable skylight with blackout and flyscreen blinds	1	1	1	1
Compact operable skylight with blackout and flyscreen blinds	-	1	1	1
Seats/three-point safety belts	4 / 4	4 / 4	4 / 4	4 / 4
Berths	2 (+1 optional)	2 (+1 optional)	2 (+1 optional)	2 (+1 optional)
Rear bed/single bed, mm (approx.)	1,960 x 1,320/1,170	1,960/1,470 x 1,300	1,960/1,570 x 1,535	1,903/1,769 x 1,900
Bed lateral to sliding door, mm (approx., as standard)	1,800 x 700	1,800 x 700	1,800 x 700	1,800 x 700
Extra bed in the rear (approx., as standard)	-	-	-	-
Possible Isofix fittings	-	1	1	1

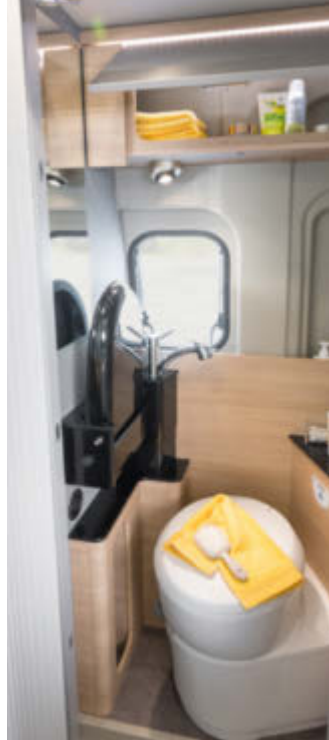

TRENDA

# TRENDA 540 R



**Practical bathroom concept**  
Bathroom with flip-up wash-hand basin

**Practical kitchen**  
Double-hinged refrigerator for easy access from inside and outside the vehicle

**Seating area for four persons**  
alternative tabletop (optional)

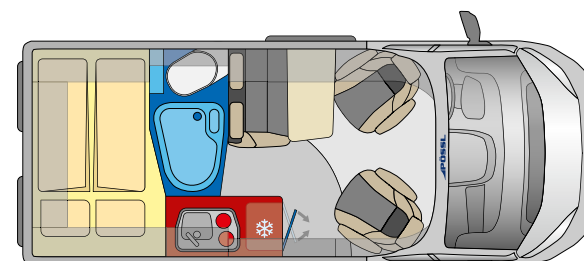

5.41 m

- Compact vehicle for day-to-day use ✓
- Practical bathroom for greater space ✓
- Convivial seating area for up to four persons ✓
- Double-hinged refrigerator can be opened from both inside and outside ✓

TRENTA



# TRENTA 600



LOOK INSIDE

360°

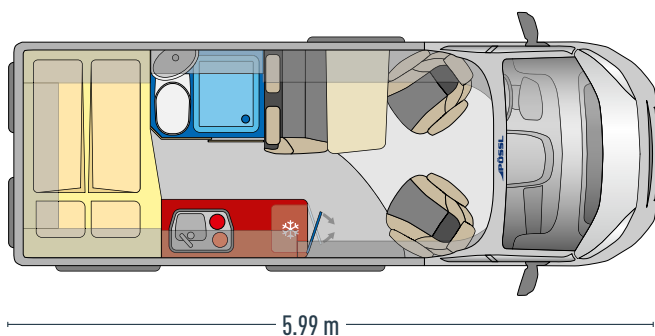

- ✓ Practical and space-saving wooden sliding door
- ✓ Spacious, open-plan interior
- ✓ Refrigerator with removable freezer compartment and can be opened in both directions
- ✓ Bench seat made of ergonomically shaped upholstery



**High-end ambience**  
alternative tabletop (optional)

**Spacious bathroom**  
With large mirror, it offers all amenities

**Comfortable sleeping**  
Large double bed in the rear

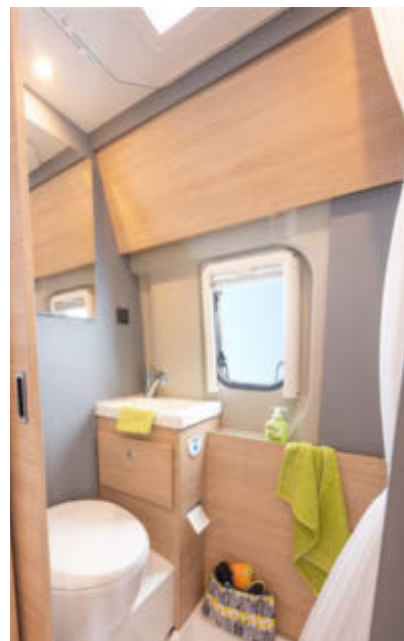



TRENTA

# TRENTA 600 R



**Comfortable sleeping**  
Large double bed in the rear

**Practical central bathroom**  
creates more space and doubles as a room divider

**Convivial seating area**  
The Tiberino wood decor goes best with top quality two-tone overhead lockers, alternative tabletop (optional)

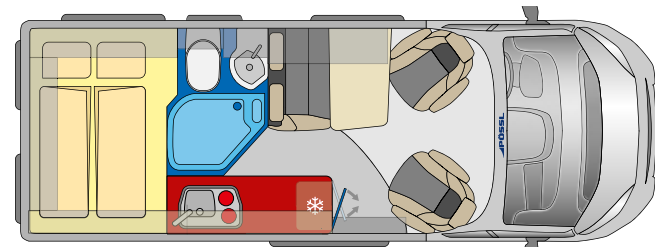

5.99 m



- Practical central bathroom provides for greater space ✓
- Spacious, open-plan interior ✓
- Bench seat made of ergonomically shaped upholstery ✓
- Double-hinged refrigerator can be accessed from outside and inside ✓

TRENTA



# TRENTA 640



LOOK INSIDE

360°

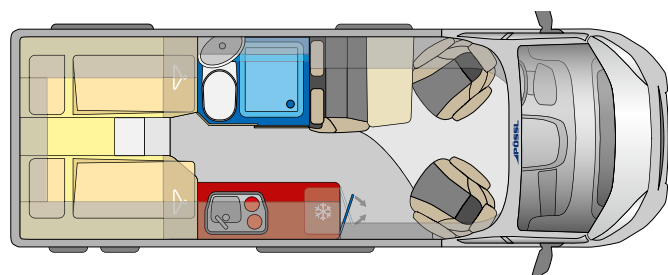

6.36 m

- ✓ Practical and space-saving wooden sliding door
- ✓ Spacious, open-plan interior
- ✓ Refrigerator with removable freezer compartment and can be opened in both directions
- ✓ Bench seat made of ergonomically shaped upholstery

### High-end ambience

The Tiberino wood decor goes perfectly with the top quality two-tone locker | Alternative tabletop (optional)

### Home-like sleeping comfort

The entire sleeping area is fitted with top quality wall panelling

### Easy access

Double-hinged refrigerator for easy access from inside and outside the vehicle





# PEAK FREEDOM OF MOBILITY



summit

summit  
prime

summit  
Shine

In 2016, with the Summit model PÖSSL launched one of the first motorhomes on a van base, featuring a swing-wall washroom and unique spatial design, thus starting its ascent to the top of mobile recreational life. Anyone seeking something even more exclusive than the Summit, may look to the Summit Prime to take them to yet greater heights. And with its Summit Shine model - a shimmering success - PÖSSL marks its ascent to the uppermost peak!



# summit Highlights



## FRAMED WINDOWS

Permanently integrated framed windows are a novelty in this class. Quality in every detail. A must-have.



## CHILD-SEAT FITTINGS

All rear seats are available with Isofix (optional).

## SWING-WALL BATHROOM

The swing wall and pivotable toilet with scratch-resistant ceramic inlay create a lot of additional bathroom space. Storage compartment in swing wall available with sanitary package.

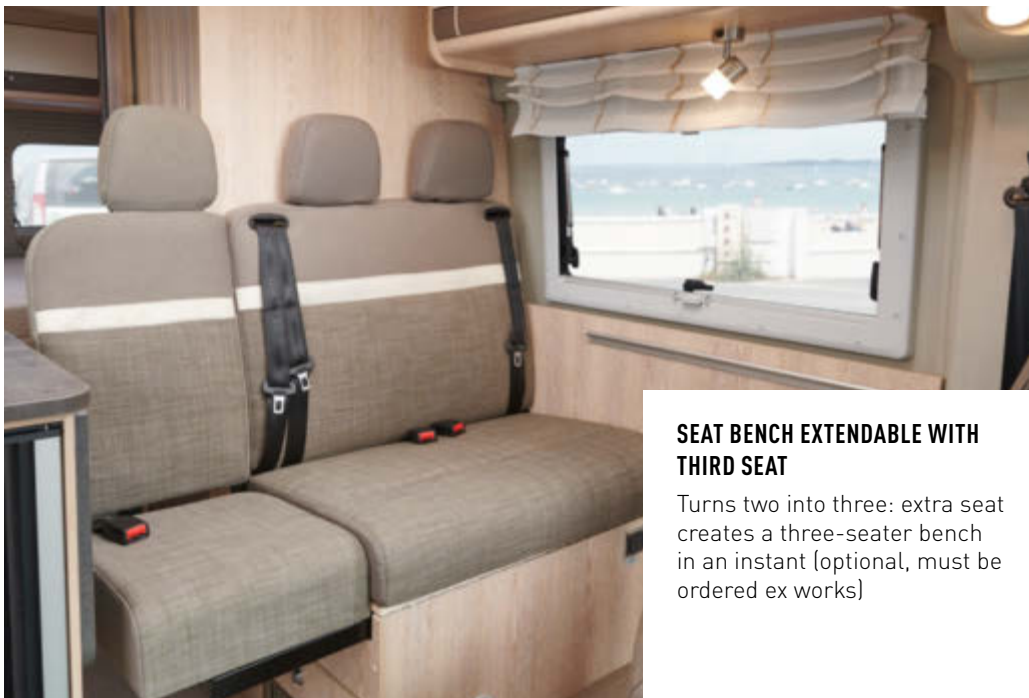

## SEAT BENCH EXTENDABLE WITH THIRD SEAT

Turns two into three: extra seat creates a three-seater bench in an instant (optional, must be ordered ex works)



## SOFT-CLOSE DRAWERS

Sizeable in a small kitchen; with convenience like at home.



## EASY MOVE TABLE (540 ONLY)

The practical stowable Easy Move table provides more legroom and greater safety on the road.

SUMMIT 540

SUMMIT 600

SUMMIT 640

6.36 m  
5.99 m  
5.41 m

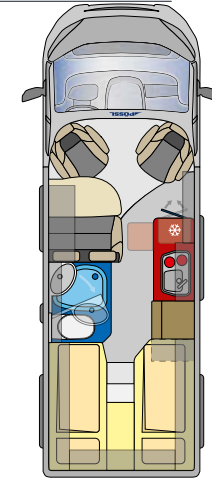
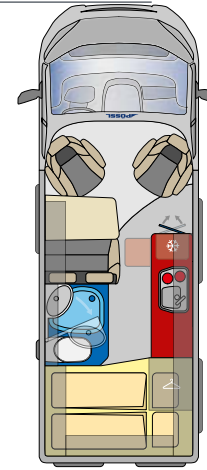
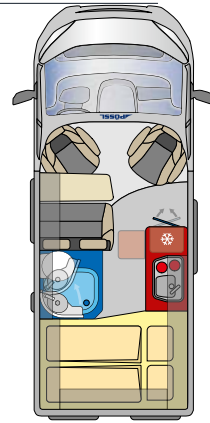

PAGE

27

28

29

**DIMENSIONS in mm**

Length (approx.)	5,413	5,998	6,358
Width (approx.)	2,050	2,050	2,050
Height (approx.)	2,580	2,580	2,580
Wheelbase (approx.)	3,450	4,035	4,035
Interior height (approx.)	1,905	1,905	1,905

**WEIGHT AND MAXIMUM RECOMMENDED LOAD in kg**

Gross vehicle weight (standard)	3,500	3,500	3,500
Mass in running order (approx.)*	2,680	2,835	2,960
Maximum recommended load with 20 l water (approx.)	820	665	540
Towing capacity, unbraked/braked**	750 / 2,500**	750 / 2,500**	750 / 2,500**

\* Weight specifications with standard built-in equipment. 165/180 HP and higher, +40 kg. The maximum recommended load will change with instalment of optional extras. \*\* Heavy/Maxi 750/3,000 kg

**ON-BOARD TECHNICAL EQUIPMENT**

Heater	Truma Combi 4	Truma Combi 4	Truma Combi 4
Boiler volume, l (approx.)	10	10	10
Fresh water tank, l (approx.)	60	100	100
Wastewater tank, l (approx.)	110	110	110
Gas cylinder box for (kg)	1 x 11 und 1 x 5	1 x 11 und 1 x 5	2 x 11
Battery charger, A	16	16	16
Battery	12V / 95 Ah	12V / 95 Ah	12V / 95 Ah
230V power sockets	1 / 2	1 / 2	1 / 2
Refrigerator, l (capacity/for freezer)	approx. 100 / 8	approx. 100 / 8	approx. 100 / 8
Absorber/compressor	Compressor	Compressor	Compressor

**LIVING AREA FITTINGS AND FEATURES**

Windows in living space	5	4	5
Skylight with blackout roller blinds	1	2	2
Seats/three-point safety belts	4 / 4 (+1 optional)	4 / 4 (+1 optional)	4 / 4 (+1 optional)
Berths	2 (+1 optional)	2 (+1 optional)	2 (+1 optional)
Rear bed, mm (approx.)	1,960 x 1,200/1,410	1,960 x 1,560/1,430	2,000/1,900 x 800 / alternative: 2,000/1,900 x 1,900
Bed lateral to sliding door, mm (approx., as standard)	1,800 x 500	1,800 x 700	1,800 x 700
Possible Isofix fittings	1	2	2



**Oak Copper Bora wood decor (optional)**

Mindoro interior (optional), Easy Move table with travel function

**Kitchenette with compressor fridge**

Double-hinged for easy access from inside and outside the vehicle



**Swing-wall bathroom**

with indirect lighting



# SUMMIT 540

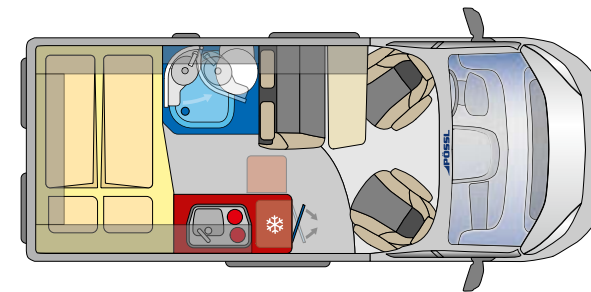

5.41 m

Additional space when travelling in the seating area thanks to the Easy Move table ✓

Bench seat made of ergonomically moulded upholstery ✓

summit

summit



ALSO AVAILABLE AS PLUS SPECIAL MODEL



# SUMMIT 600



LOOK INSIDE

360°

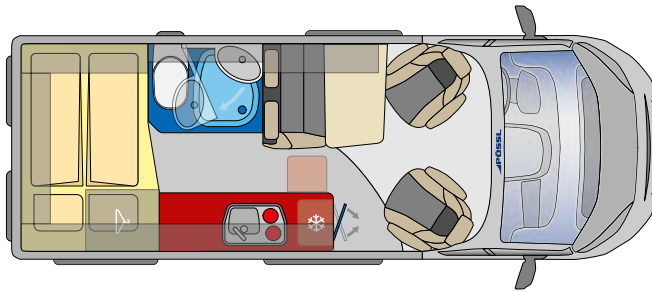

5.99 m

- ✓ Ingenious room-in-room solution with swing-wall washroom
- ✓ Refrigerator with removable freezer compartment, openable in both directions

### Copper Bora wood decor (optional)

Mindoro interior (optional), alternative tabletop (optional)

### Comfortable sleeping

Large double bed in the rear

### Comfy seating area

For convivial gatherings of up to four persons





summit

# SUMMIT 640



### Culinary-based, practical design

The extra-large kitchenette features a large 100 L fridge for local homegrown delicacies on the road

### Sleep like a king

Two large single beds in the rear for restful nights in hotel-like comfort

### Copper Bora wood decor (optional)

Mindoro interior (optional), alternative tabletop (optional)

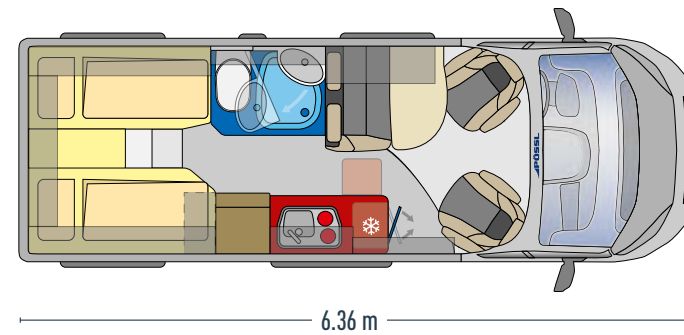

- Spacious, open-plan interior ✓
- Top quality framed windows for a special automotive look ✓



### FRONT WINDSCREEN BLACKOUT BLIND

From bottom to top: for larger field of vision out front and greater privacy. When it's half-closed, everybody can look out, but nobody can look in.



### SKYROOF®

Pop-up SkyRoof® with flyscreen and blackout blind.



### UNIQUE AMBIENCE

canopy with indirect lighting and additional LEDs for optimum illumination of the seating area.



### REFRIGERATOR DOOR

The double-hinged refrigerator door provides access from the outside and inside.

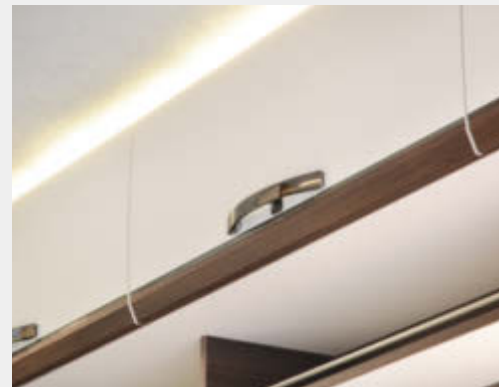

### NEW PRIME LIGHTING DESIGN

The lighting was designed exclusively for the Prime and creates a comfortable and cosy ambience.



### SKYROOF® FROM INSIDE

Unique open-plan spatial concept with lots of head and legroom, like in a liner motorhome.

## SUMMIT PRIME 540

## SUMMIT PRIME 600

## SUMMIT PRIME 640

6.36 m  
5.99 m  
5.41 m

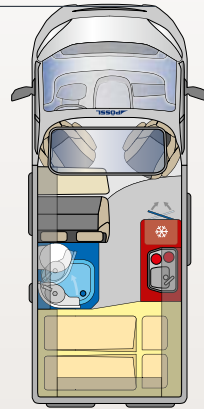

32

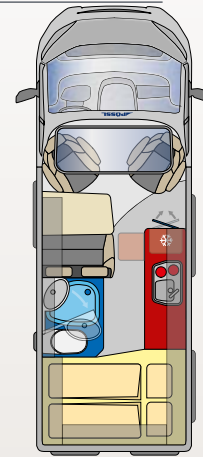

33

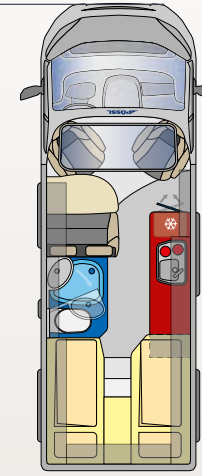

34

PAGE

### DIMENSIONS in mm

Length (approx.)	5,413	5,998	6,358
Width (approx.)	2,050	2,050	2,050
Height (approx.)	2,580	2,580	2,580
Wheelbase (approx.)	3,450	4,035	4,035
Interior height (approx.)	1,905	1,905	1,905

### WEIGHT AND MAXIMUM RECOMMENDED LOAD in kg

Gross vehicle weight (standard)	3,500	3,500	3,500
Mass in running order (approx.)*	2,695	2,890	3,010
Maximum recommended load with 20 l water (approx.)	805	610	490
Towing capacity, unbraked/braked**	750 / 2,500**	750 / 2,500**	750 / 2,500**

\* Weight specifications with standard built-in equipment. 165/180 HP and higher, +40 kg. The maximum recommended load will change with instalment of optional extras. \*\* Heavy/Maxi 750/3,000 kg

### ON-BOARD TECHNICAL EQUIPMENT

Heater	Truma Combi 4	Truma Combi 4	Truma Combi 4
Boiler volume, l (approx.)	10	10	10
Fresh water tank, l (approx.)	60	100	100
Wastewater tank, l (approx.)	110	110	110
Gas cylinder box for (kg)	1 x 11 und 1 x 5	1 x 11 und 1 x 5	2 x 11
Battery charger, A	16	16	16
Battery	12V/ 95 Ah	12V/ 95 Ah	12V/ 95 Ah
230V power sockets	1 / 2	1 / 2	1 / 2
Refrigerator, l (capacity/for freezer)	approx. 100 / 8	approx. 100 / 8	approx. 100 / 8
Absorber/compressor	Compressor	Compressor	Compressor

### LIVING AREA FITTINGS AND FEATURES

Windows in living space	6	6	5
Skylight with blackout roller blinds	1	2	2
Seats/three-point safety belts	4 / 4 (+1 optional)	4 / 4 (+1 optional)	4 / 4 (+1 optional)
Berths	2 (+1 optional)	2 (+1 optional)	2 (+1 optional)
Rear bed, mm (approx.)	1,960 x 1,200/1,410	1,960 x 1,560/1,430	2,000/1,900 x 800 / alternative: 2,000/1,900 x 1,900
Bed lateral to sliding door in mm (approx., as standard)	1,800 x 500	1,800 x 700	1,800 x 700
Possible Isofix fittings	1	2	2

SUMMIT PRIME AT A GLANCE

Summit  
prime



# SUMMIT PRIME 540



LOOK INSIDE

360°

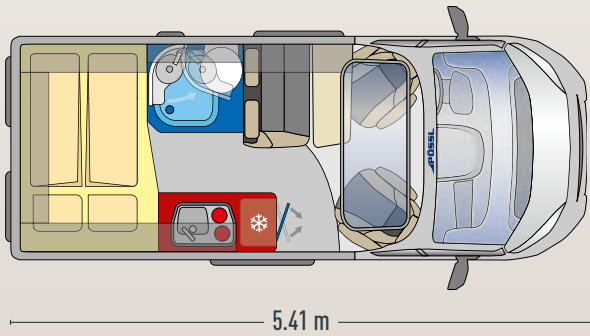

### Modern ambience

Palisander wood decor, Samba interior (optional)

### Kitchenette with compressor fridge

Double-hinged for easy access from inside and outside the vehicle

### Comfy seating area

Easy Move table with travel function



- ✓ Easy Move table with travel function
- ✓ Lighting fixtures under roof cabinet with night light function





**High-end ambience**

Palisander wood decor, Samba interior (optional)

**Spacious swing-wall bathroom**

Our premium luxury-class bathroom concept

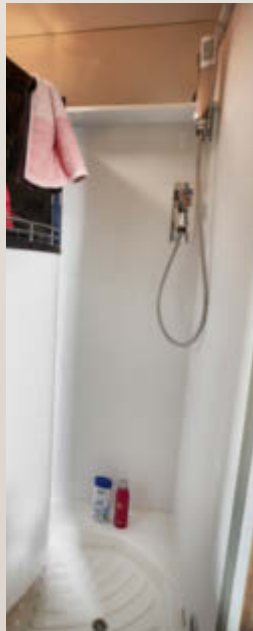

**Just like sleeping in your own bed**

In the largest double bed in its class (1,960 mm x 1,600/1,470 mm)



**SUMMIT PRIME 600**

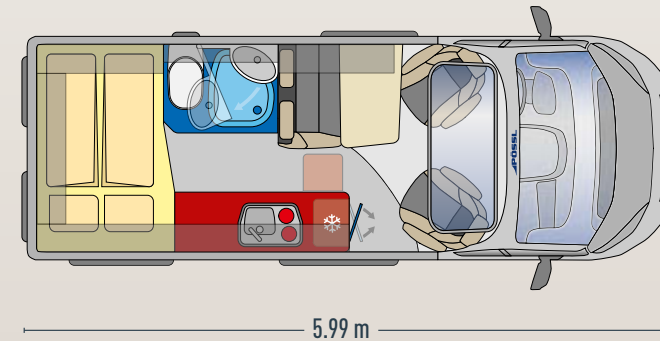

**Ingenious room-in-room solution with swing-wall bathroom**  
**Spacious, open-plan interior created by SkyRoof®**



**Extra-large seating area**

With ergonomic moulded seat pads, table with open-out section (optional)

summit  
prime



LOOK INSIDE

360°

# SUMMIT PRIME 640

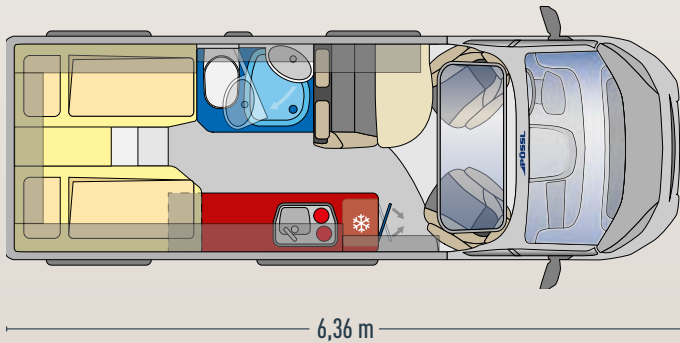

- ✓ Spacious interior like in a liner motorhome
- ✓ Bench seat made of ergonomically moulded upholstery
- ✓ Top quality framed windows for a special automotive look

### Modern ambience

Palisander wood decor, Samba interior (optional)

### Kitchenette with compressor fridge

Double-hinged for easy access from inside and outside the vehicle

### Sleep like a king

Two large single beds in the rear for restful nights in hotel-like comfort

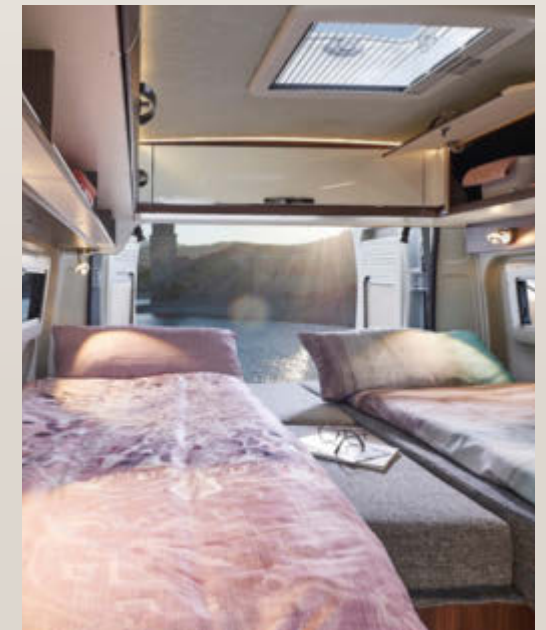





### FLEXIBLE STOWAGE SPACE CONCEPT

Depending on what you need, the MultiRoof shelf (optional) can be effortlessly lowered to create more storage space above the driver's cab. When it's not needed, the shelf can be simply pushed upwards into place or even removed completely.



### TOP QUALITY LIGHT RAILS

The matching spots and USB sockets of the light rail in anthracite add up to an especially modern design.

### SPACIOUS CEILING CABINETS

The guardrail in the ceiling cabinets additionally secures large and heavy items, while the optically continuous LED strips in the hatches provide even more light.



### EASY MOVE TISCH

The travel function is a practical feature enabling the table to be stowed away, creating more legroom (Summit Shine 540/540 R and 600L/600L R).



## WASHROOM

Wet cell and room divider in one: The roller shutter transforms the interior into a spacious shower.



## INNOVATIVE SEATING AREA

Single seat with extension for hinged seat (optional) or space for up to five persons thanks to optional 2+1 bench seat.



## SWING-WALL WASHROOM

The swing wall means the shower and pivotable toilet with wash basin can be separate areas. With scratch-resistant ceramic inlay and storage facility.

SUMMIT SHINE 540

SUMMIT SHINE 600

SUMMIT SHINE 600L

SUMMIT SHINE 640

6.36 m  
5.99 m  
5.41 m

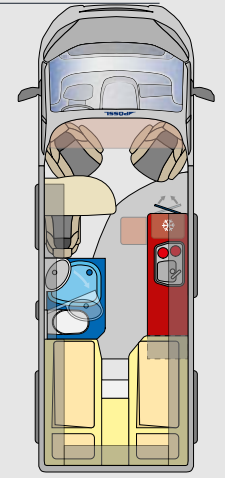
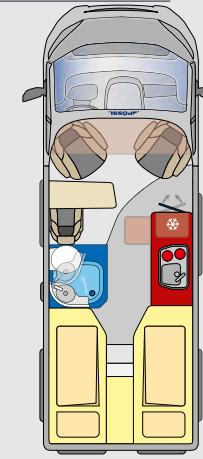
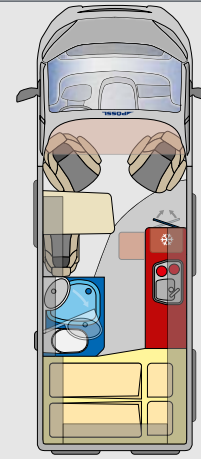
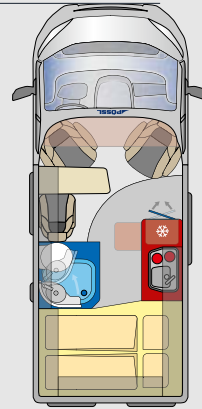

PAGE

40

41

41

42

**DIMENSIONS in mm**

Length (approx.)	5,413	5,998	5,998	6,358
Width (approx.)	2,050	2,050	2,050	2,050
Height (approx.)	2,580	2,580	2,580	2,580
Wheelbase (approx.)	3,450	4,035	4,035	4,035
Interior height (approx.)	1,905	1,905	1,905	1,905

**WEIGHT AND MAXIMUM RECOMMENDED LOAD in kg**

Gross vehicle weight (standard)	3,500	3,500	3,500	3,500
Mass in running order (approx.)*	2,695	2,835	2,890	2,960
Maximum recommended load with 20 l water (approx.)	805	665	610	540
Towing capacity, unbraked/braked**	750 / 2,500**	750 / 2,500**	750 / 2,500**	750 / 2,500**

\* Weight specifications with standard built-in equipment. 165/180 HP and higher, +40 kg. The maximum recommended load will change with instalment of optional extras. \*\* Heavy/Maxi 750/3,000 kg

**ON-BOARD TECHNICAL EQUIPMENT**

Heater	Truma Combi 4	Truma Combi 4	Truma Combi 4	Truma Combi 4
Boiler volume, l (approx.)	10	10	10	10
Fresh water tank, l (approx.)	60	100	100	100
Wastewater tank, l (approx.)	110	110	110	110
Gas cylinder box for (kg)	1 x 11 und 1 x 5	1 x 11 und 1 x 5	1 x 11 und 1 x 5	2 x 11
Battery charger, A	16	16	16	16
Battery	12V / 95 Ah	12V / 95 Ah	12V / 95 Ah	12V / 95 Ah
230V power sockets	1 / 2	1 / 2	1 / 2	1 / 2
Refrigerator, l (capacity/for freezer)	approx. 100 / 8	approx. 100 / 8	approx. 100 / 8	approx. 100 / 8
Absorber/compressor	Compressor	Compressor	Compressor	Compressor

**LIVING AREA FITTINGS AND FEATURES**

Windows in living space	5	6	5	5
Skylight with blackout roller blinds	1	2	2	2
Seats/three-point safety belts	3 / 3 (+1 optional) or / 4 / 4 (+1 optional)	3 / 3 (+1 optional) or / 4 / 4 (+1 optional)	3 / 3 (+1 optional) or / 4 / 4 (+1 optional)	3 / 3 (+1 optional) or / 4 / 4 (+1 optional)
Berths	2 (+1 optional)	2 (+1 optional)	2 (+1 optional)	2 (+1 optional)
Rear bed, mm (approx.)	1,960 x 1,200/1,410	1,960 x 1,560/1,430	2,000/1,800 x 800 / alternative: 2,000/1,800 x 1,900	2,000/1,900 x 800 / alternative: 2,000/1,900 x 1,900
Third bed in mm (approx. as standard)	1,600 x 720/650 x 100	1,600 x 720/650 x 100	1,600 x 720/650 x 100	1,600 x 720/650 x 100
Possible Isofix fittings	1	2	1	2

## SUMMIT SHINE 540 R

## SUMMIT SHINE 600 LR

## SUMMIT SHINE 640 R

6.36 m  
5.99 m  
5.41 m



43

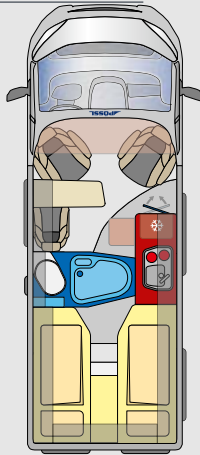

44

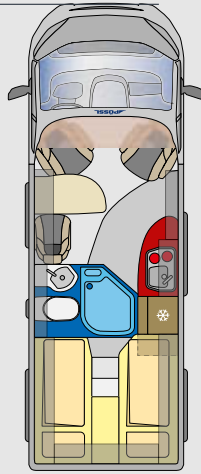

45

5,413	5,998	6,358
2,050	2,050	2,050
2,580	2,580	2,580
3,450	4,035	4,035
1,905	1,905	1,905
3,500	3,500	3,500
2,695	2,890	2,960
805	610	540
750 / 2,500**	750 / 2,500**	750 / 2,500**
Truma Combi 4	Truma Combi 4	Truma Combi 4
10	10	10
60	100	100
110	110	110
1 x 11 und 1 x 5	1 x 11 und 1 x 5	2 x 11
16	16	16
12V / 95 Ah	12V / 95 Ah	12V / 95 Ah
1 / 2	1 / 2	1 / 2
approx. 100 / 8	approx. 100 / 8	approx. 84 / 6
Compressor	Compressor	Compressor
5	5	5
3	4	4
3 / 3 (+1 optional) or / 4 / 4 (+1 optional)	3 / 3 (+1 optional) or / 4 / 4 (+1 optional)	3 / 3 (+1 optional) or / 4 / 4 (+1 optional)
2 (+1 optional)	2 (+1 optional)	2 (+1 optional)
1,960 x 1,200 / 1,410	2,000 / 1,800 x 800 / alternative: 2,000 / 1,800 x 1,900	2,000 / 1,900 x 800 / alternative: 2,000 / 1,900 x 1,900
1,600 x 720 / 650 x 100	1,600 x 720 / 650 x 100	1,600 x 720 / 650 x 100
1	1	2

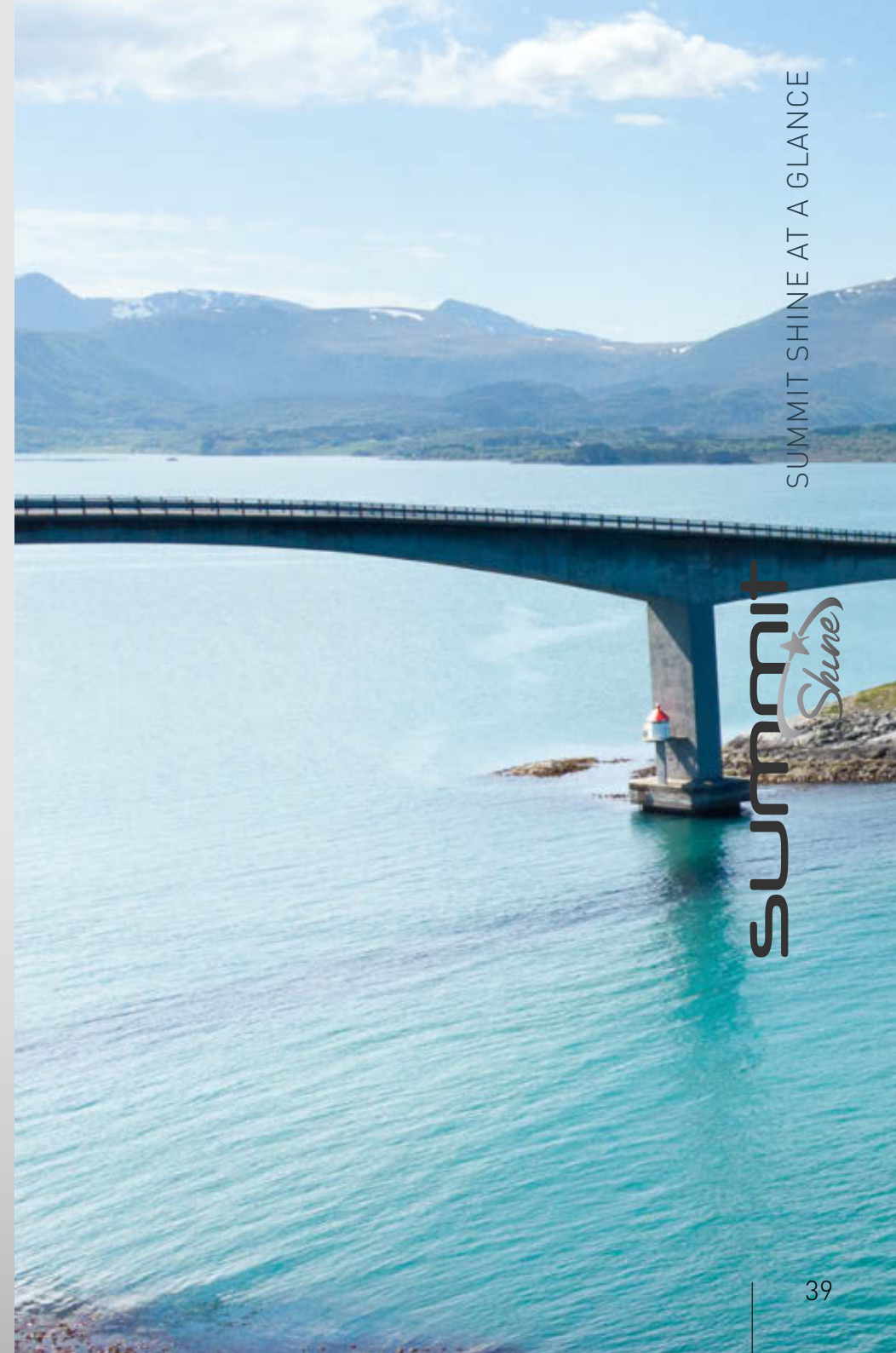

SUMMIT SHINE AT A GLANCE

Summit Shine



LOOK INSIDE

360°

# SUMMIT SHINE 540

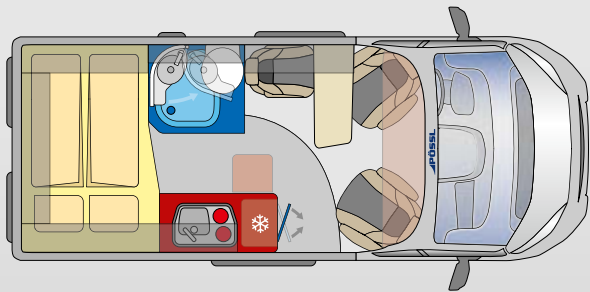

5.41 m

- ✔ Atmospheric lighting throughout living space
- ✔ Appealing seating area with Easy Move table incl. travel function

### Mocha wood decor

Grigio Lucente interior, Easy Move table with travel function

### Kitchen with compressor refrigerator

Larger work surface thanks to foldaway board







01

01

**Mocha wood decor**

Grigio Lucente interior, convenient table with open-out section

02

**Cosy lateral bed**

for snuggle-up time



02

- ✓ **Flexible seating arrangement provided by single or double seat, each with extension option**

- ✓ **Spacious swing-wall bathroom for more space**



01

01

**Mocha wood decor**

Grigio Lucente interior, Easy Move table with travel function

02

**Large length-wise bed**

on compact vehicle base



02

- ✓ **Top quality light rails in anthracite matching spots and USB sockets**

- ✓ **Sleeping comfort in length-wise bed on 6-metre long vehicle base**

# SUMMIT SHINE 600

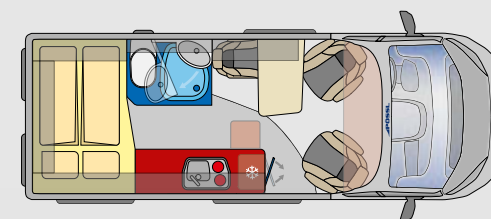

5.99 m



summit Shine

# SUMMIT SHINE 600 L

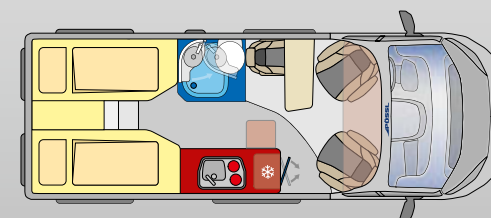

5.99 m



# SUMMIT SHINE 640



LOOK INSIDE

360°

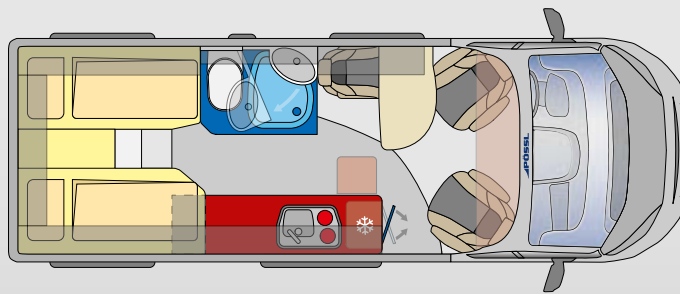

6,36 m

### Mocha wood decor

Grigio Lucente interior, convenient table with open-out section

### Practical and innovative

Large swing-wall bathroom

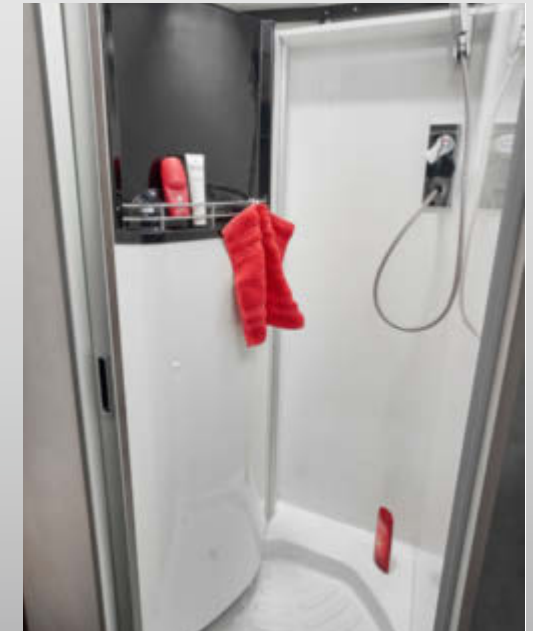

- ✔ Open driver's cab and storage miracle in one: MultiRoof with optional storage space
- ✔ Especially bright interior thanks to light rail and indirect illuminating storage hatches



**Mocha wood decor**

Grigio Lucente interior, Easy Move table with travel function, twin bench seat (optional)

**Kitchenette with compressor fridge**

Double-hinged for easy access from inside and outside the vehicle



**Bathroom**

Wet cell and room divider in one



**SUMMIT SHINE 540 R**

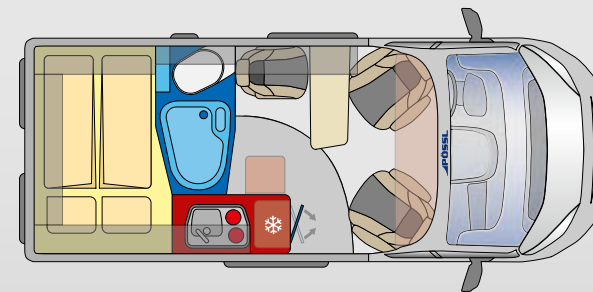

5.41 m

**Additional space when travelling in the seating area thanks to the Easy Move table**



**Bench seat made of ergonomically moulded upholstery**



summit  
Shine



# SUMMIT SHINE 600 LR



LOOK INSIDE

360°

### Mocha wood decor

Grigio Lucente interior, convenient table with travel function, twin bench seat (optional)

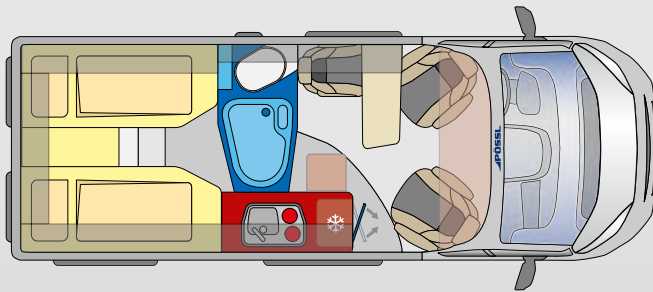

5.99 m

### Large length-wise bed

on compact vehicle base



- ✓ Top quality light rails in anthracite matching spots and USB sockets
- ✓ Sleeping comfort in length-wise bed on 6-metre long vehicle base



**Seating area with twin bench seat (optional)**  
Mocha standard decor and Grigio Lucente interior



summit  
Shine

# SUMMIT SHINE 640 R



**Open plan round kitchen**  
offering loads of space at the cooker



**Large-sized bathroom**  
with window

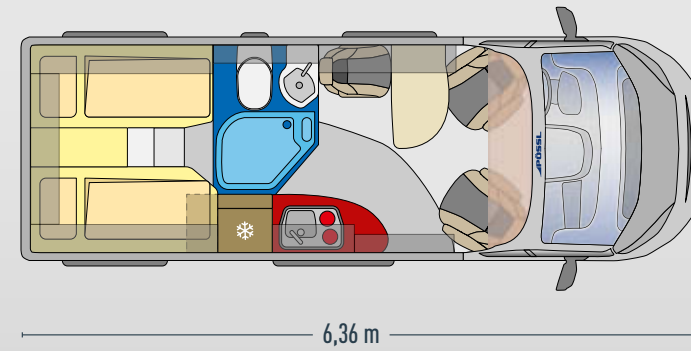

- New kitchen design for more space in the van base** ✓
- pleasant nights in the large longitudinal bed** ✓

summit

summit  
prime

summit  
Shine

# Interior

## DECOR



**STANDARD SUMMIT  
ROSEWOOD DECOR**



**ALTERNATIVE OAK COPPER  
BORA WOOD DECOR**



**SUMMIT PRIME PALISANDER  
STANDARD DECOR**



**STANDARD DECOR SUMMIT SHINE  
MOCHA**

## WOHNWELTEN



**MINDORO INTERIOR (STANDARD IN SUMMIT PRIME)**



**SAMBA INTERIOR**



**ORIGINAL CAPTAIN CHAIR INTERIOR  
(STANDARD IN SUMMIT)**



**GRIGIO LUCENTE INTERIOR  
(STANDARD WITH SUMMIT SHINE)**



# AT HOME THE WORLD OVER



## H line

Discover the world - with a motorhome that's unbeatable in space and quality. And all that at a totally fair price. Welcome to the H-Line - built for everyone for whom the journey is the reward. Built for truly great freedom to travel.



# H line Highlights



## FRAMED WINDOWS

A novelty in this class: solidly installed framed windows – quality lies in the detail.



## HEIGHT-ADJUSTABLE OVERCAB BED AREA

The interior sides have a high quality, protective crumpled velour finish.



## REFRIGERATOR DOORS

The double-hinged refrigerator doors give you flexible access.



## TOP QUALITY FURNITURE

All furniture in the vehicle is manufactured in our factory in Germany.

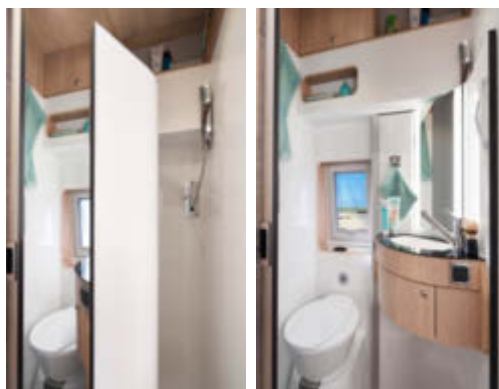

## 2WIN VARIO ONLY SWING-WALL BATHROOM

Creates more room and sense of space.



## 5TH SEAT (OPTIONAL WITH VARIO 545/2WIN VARIO)

By extending the bench, two seats are transformed into three in an instant.



## 2WIN VARIO

Rear window in high roof (optional), rear doors with windows (optional)



## VARIO 545

Rear window in high roof (optional), rear doors with windows (optional), rear bed (optional)



## CONCORDE COMPACT

Rear window in high roof (optional)

The stowage miracle

## VARIO 545

## CONCORDE COMPACT

## 2WIN VARIO

5.99 M

5.41 M

Plenty of space in the world's most beautiful spots.

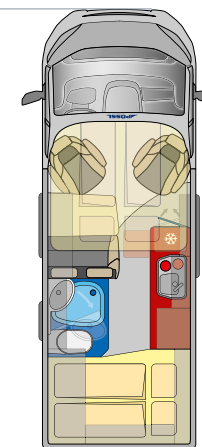
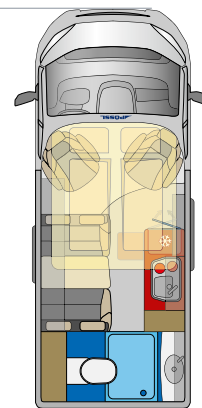
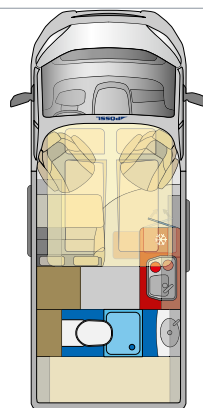

PAGE

43

44

45

DIMENSIONS in mm			
Length (approx.)	5,413	5,413	5,998
Width (approx.)	2,050	2,050	2,050
Height (approx.)	3,120	3,120	3,120
Wheelbase (approx.)	3,450	3,450	4,035
Interior height (approx.)	2,450	2,450	2,450
WEIGHT AND MAXIMUM RECOMMENDED LOAD in kg			
Gross vehicle weight (standard)	3,500	3,500	3,500
Mass in running order (approx.)*	2,843	2,823	2,999
Maximum recommended load with 20 l water (approx.)	657	677	501
Towing capacity, unbraked/braked**	750/2,500	750/2,500	750/2,500

\* Weight specifications with standard built-in equipment. 165/180 HP and higher, +40 kg. The maximum recommended load will change with instalment of optional extras. \*\* Heavy/Maxi 750/3,000 kg

ON-BOARD TECHNICAL EQUIPMENT			
Heater	Truma Combi 4	Truma Combi 4	Truma Combi 4
Boiler volume, l (approx.)	10	10	10
Fresh water tank, l (approx.)	75	75	100
Wastewater tank, l (approx.)	80	80	80
Gas cylinder box for (kg)	2 x 11	2 x 11	2 x 11
Battery charger, A	16	16	16
Battery	12V / 95 Ah	12V / 95 Ah	12V / 95 Ah
230V power sockets	2 / 1	1/1	1/1
Refrigerator, l (capacity/for freezer)	approx. 100/8 l	approx. 100/8 l	approx. 100/8 l
Absorber/compressor	Compressor	Compressor	Compressor

LIVING AREA FITTINGS AND FEATURES			
Windows in living space	2	2	3
Skylight with blackout roller blind	2	1	2
Lateral skylight	2	2	2 (+1 standard configuration rear)
Seats/three-point safety belts	4/4	4/4 (+2 optional)	4/4
Berths	2 (+1/+2 optional)	2 (+2 optional)	2 (+1/+2 optional)
Rear bed/bunk beds, mm (approx.)	below: 1,960 x 740 (standard) above: 1,670 x 670 (standard)	Dinette 1,960 x 850/780 (standard)	1,950 x 1,400/1,200
Height-adjustable bed/roof bed, mm (approx.)	2,200 x 1,700	2,150 x 1,700	2,050 x 1,350 (SA)
Bed lateral to sliding door, mm (approx., as standard)	1,800 x 700	-	1,800 x 700



**Mindoro interior (optional)**

Oak Copper Bora wood decor, table with open-out section (optional), rear beds (optional), ambient lighting (optional)

**Roof bed and removable rear bed (optional)**

Without rear bed there is extra storage space; with rear bed there is sleeping space for up to 4 persons

**Central bathroom**

Also serves a room divider to rear bedroom

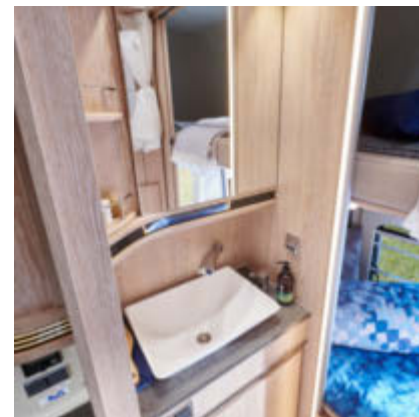

# VARIO 545

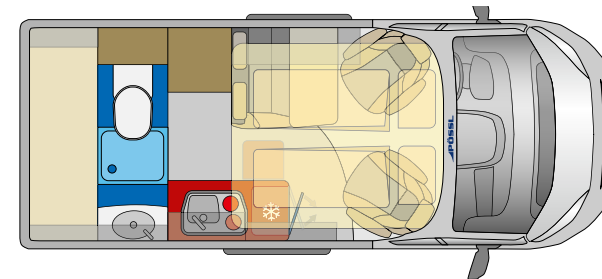

5.41 m

- Extra storage space in the rear – optionally with rear beds too ✓
- Top quality framed windows for a particularly automotive look ✓
- Powerful compressor refrigerator – can be opened in both directions, removable freezer compartment ✓



# CONCORDE COMPACT



LOOK INSIDE

360°

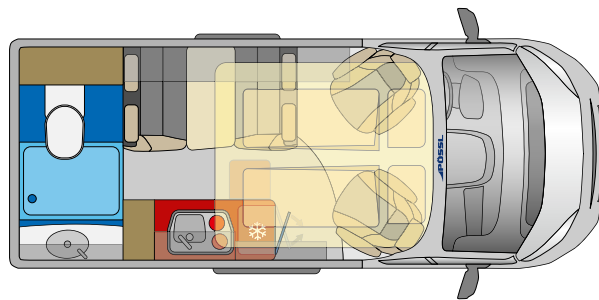

5.41 m

- ✔ Bespoke motorhome using high quality materials
- ✔ Cosy and spacious seating area for up to four persons
- ✔ Separate bathroom
- ✔ Powerful compressor refrigerator – can be opened in both directions, removable freezer compartment

### Mindoro interior (optional)

Oak Copper Bora wood decor, table with open-out section (optional), rear beds (optional), ambient lighting (optional)

### Luxury kitchen

2-burner hob with piezo ignition



### Bathroom in the rear

Spacious bathroom over the entire width of the rear

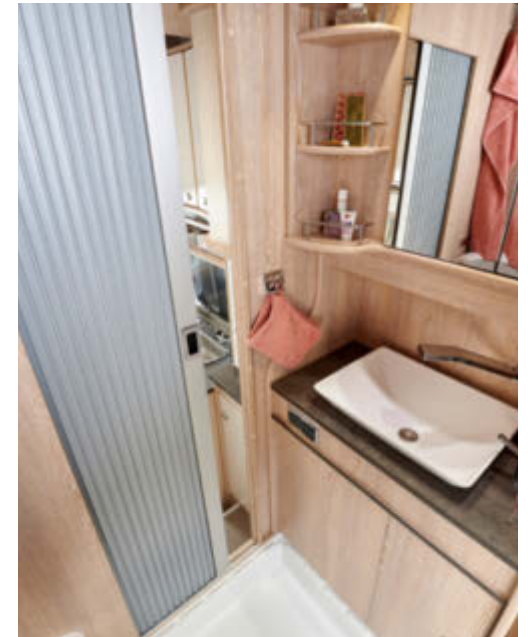



HLINE

# 2WIN VARIO



### Two full-size bedrooms

Large double bed in the rear and roof bed (optional)

### Large swing-wall bathroom

Enables even better use of space

### Mindoro interior (optional)

Oak Copper Bora wood decor, table with open-out section (optional), bed for high roof (optional), rear door windows (optional)

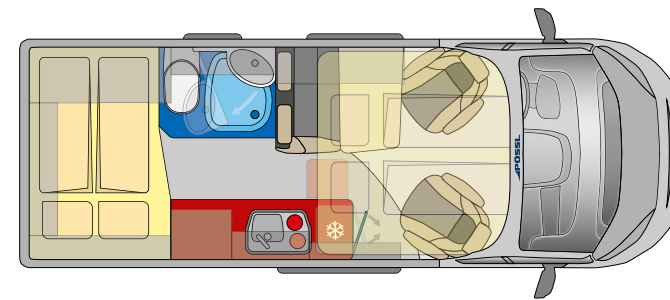

5.99 m

- With swing-wall bathroom as standard ✓
- Spacious kitchen with extra storage compartments ✓
- Powerful compressor refrigerator – can be opened in both directions, removable freezer compartment ✓

# Hline

## Interior

DECOR



STANDARD DECOR  
OAK COPPER BORA

## INTERIORS



ORIGINAL CAPTAIN CHAIR INTERIOR (STANDARD)



SAMBA INTERIOR (OPTIONAL)



MINDORO INTERIOR (OPTIONAL)

# Exterior

**THERE'S SOMETHING FOR EVERY PÖSSL HERE - D-LINE, TRENTA, SUMMIT OR H-LINE**

Make your PÖSSL even more stylish. It's easy as can be, with a choice of paintwork and stylish modern-looking alloy wheels.

## ALLOY WHEELS

Light 16"

Maxi/Heavy 16"

Fiat



Citroën / Peugeot



## PAINTWORK

Fiat / Citroën / Peugeot

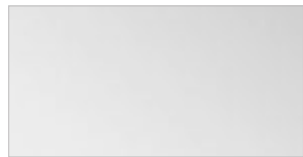

Campovolo Grey/ Expedition Grey



Artense Grey metallic



Iron Grey metallic



Lanzarote Grey/ Thunder Grey



Black metallic/ Graphito Grey metallic

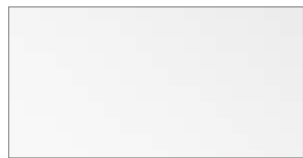

White



[facebook.com/poessltreisemobile](https://facebook.com/poessltreisemobile)



[instagram.com/poessler\\_original](https://instagram.com/poessler_original)



[youtube.com/poesslergroup](https://youtube.com/poesslergroup)



[pinterest.de/poesslergroup](https://pinterest.de/poesslergroup)



[vimeo.com/poesslergroup](https://vimeo.com/poesslergroup)



[linkedin.com/company/poesslergroup](https://linkedin.com/company/poesslergroup)



With dealerships in 14 countries – we're ready to assist you! And of course, on **[www.poessler-mobile.de](http://www.poessler-mobile.de)**

A BRAND OF

PÖSSL GROUP

Rights reserved concerning technical specifications and errors. Please note that illustrations in this brochure may contain decorations, alternative designs or special equipment that are not included in the scope of delivery or for which additional charges may be incurred. All dimensions in millimetres, unless otherwise indicated. Information on technology, water supply and prices can be found in the separate price list. Minor deviations in colour may result due to the printing process. Prices include the currently applicable statutory value added tax. Update 08/2023

\*According to EC Directive 97/27 EC and EU standard EN 1645-2, the "mass in running order" comprises the unladen weight of the vehicle, incl. driver (75 kg) and filled fuel tank, as well as the following basic equipment: water tank with reduced volume (20 l), a filled aluminium gas cylinder (15 kg) and a cable reel (4 kg). The technically permissible gross vehicle weight must not be exceeded when the personal equipment, persons travelling with the vehicle and any optional extras are taken into account. Installation of special accessories will reduce the maximum recommended load and may reduce the permitted number of persons. The information on the scope of delivery, appearance, performance, dimensions and weight of the vehicles corresponds to the knowledge available at the time of going to press, and the European homologation regulations. These can change up until the time the vehicle is purchased or until delivery. Deviations within the factory tolerances (+/- 5% max.) are possible and permissible.